



# Dolphin PCI Express PXH822 Adapter



PXH822 Transparent Adapter Users Guide  
Version 1.19

Date: 30<sup>th</sup> November 2023



## Table of Contents

<b>DISCLAIMER</b> .....	<b>4</b>
<b>TERMS AND ACRONYMS</b> .....	<b>4</b>
<b>PXH822 HIGH LEVEL SPECIFICATION</b> .....	<b>5</b>
SPECIFICATIONS .....	5
MTBF BY TEMPERATURE AND ENVIRONMENT .....	5
<b>PACKAGING</b> .....	<b>7</b>
<b>PRE-INSTALLATION QUESTIONS</b> .....	<b>7</b>
PCIe SLOT DETERMINATION.....	7
PXH822 HOST / TARGET CONFIGURATION.....	7
OPERATING ENVIRONMENT.....	7
CABLE PORTS AND CONNECTIONS.....	8
<i>Cable ports</i> .....	8
<i>PCI Express 3.0 cables</i> .....	8
<i>MiniSAS-HD cables</i> .....	8
<i>Active Optical Cables (AOC)</i> .....	8
CMI FUNCTIONALITY .....	8
<i>REAR-IO</i> .....	8
<b>INSTALLATION</b> .....	<b>9</b>
STEP 1 - UNPACK BOARD .....	9
STEP 2 - CONFIGURE THE BOARD FOR PROPER OPERATION .....	9
<i>DIP Switch Bank – Configuration</i> .....	9
<i>DIP-Switch settings for Host operation</i> .....	10
<i>DIP-Switch settings for Target operation</i> .....	11
STEP 3 - INSTALL THE ADAPTER CARD.....	11
STEP 4 - INSTALLING AND REMOVING THE CABLE.....	11
<i>Connecting the Cable</i> .....	11
<i>Disconnecting the Cable</i> .....	12
STEP 6 - VERIFY INSTALLATION & LEADS .....	12
USE CASES.....	13
<i>Use Case A - 1 Host – Single Expansion Configuration</i> .....	13
<i>Use Case B – 1 Host - Dual Expansion Configuration</i> .....	14
<i>Use Case C – 1 Host - Quad Expansion Configuration</i> .....	14
EEPROM AND FIRMWARE UPGRADE .....	15
IDENTIFYING THE CARD.....	15
<b>TECHNICAL INFORMATION</b> .....	<b>16</b>
PCIe CABLE PORT SIGNALS .....	16
EXTERNAL PCIe x4 CABLE CONNECTOR PIN-OUT .....	16
PCIe CABLE PORT MAPPING .....	16
<b>COMPLIANCE AND REGULATORY TESTING</b> .....	<b>17</b>
<b>LIMITED WARRANTY</b> .....	<b>18</b>
WARRANTY PERIOD.....	<b>ERROR! BOOKMARK NOT DEFINED.</b>
COVERAGE.....	<b>ERROR! BOOKMARK NOT DEFINED.</b>
SERVICE PROCEDURE .....	<b>ERROR! BOOKMARK NOT DEFINED.</b>
<b>PRODUCT REVISION HISTORY</b> .....	<b>19</b>

BMC FIRMWARE VERSIONS .....	19
EEPROM VERSIONS .....	19
SUPPORT .....	<b>ERROR! BOOKMARK NOT DEFINED.</b>

## DISCLAIMER

DOLPHIN INTERCONNECT SOLUTIONS RESERVES THE RIGHT TO MAKE CHANGES WITHOUT FURTHER NOTICE TO ANY OF ITS PRODUCTS TO IMPROVE RELIABILITY, FUNCTION, OR DESIGN.

TO THE FULLEST EXTENT PERMITTED BY LAW, DOLPHIN WILL NOT BE LIABLE FOR ANY INDIRECT, INCIDENTAL, SPECIAL OR CONSEQUENTIAL DAMAGES (INCLUDING LOST PROFITS, LOST DATA, OR LOSS OF USE) ARISING OUT OF ANY USE OF DOLPHIN'S PRODUCTS, SOFTWARE OR SERVICE PROVIDED. DOLPHIN'S MAXIMUM LIABILITY WILL NOT EXCEED THE TOTAL AMOUNT PAID FOR THE PRODUCT BY THE PURCHASER.

Do not use information in this guide to design your own card, always reference the original PCI-SIG or VITA Specification for details.

### LIFE SUPPORT POLICY

DOLPHIN INTERCONNECT SOLUTIONS' PRODUCTS ARE NOT AUTHORIZED FOR USE AS CRITICAL COMPONENTS IN LIFE SUPPORT DEVICES.

### ENVIRONMENTAL POLICY

Dolphin is minimizing the amount of printed documentation and software CDs in its shipments; please download additional documentation and software from [www.dolphinics.com](http://www.dolphinics.com).

## Terms and Acronyms

Important terms and acronyms used in this manual

AOC	Active Optical Cable. PCIe fiber cable assembly with SFF-8644 connector. Available from Dolphin, orderable part number MSFCxxxM (where xxx is the length in meters).
CMI	Cable Management Interface. The 2-wire management interface for communication between subsystems connected by a PCIe 3.0 cable. Details can be found in the PCI-SIG External Cabling Specification 3.0.
BMC	Microcontroller on the PXH822 used to manage card functionality and CMI communications.
eXpressWare	Dolphin's software stack for PCIe clustering and IO. Please visit <a href="http://www.dolphinics.com">www.dolphinics.com</a> for more information.
Lane	One PCI Express Lane contains a differential pair for transmission and a differential pair for reception.
Link	A collection of one or more PCI Express Lanes providing the communication path between an Upstream and Downstream Port.
MiniSAS-HD	Standard cable without CMI support. SFF-8644 connectors.
PCIe 3.0 cable	PCIe cable compliant to the new PCI-SIG External Cabling Specification 3.0. Support for CMI. SFF-8644 connectors.
Port	The PXH822 has four x4 ports, named P1, P2, P3, P4. The physical ports are identified by text on the Front panel face plate.
Wake	A mechanism used by a downstream device to request the reapplication of main power when in the L2 Link state.

## PXH822 High Level Specification

The PXH822 is a PCI Express Gen3 x16 Transparent XMC adapter card that can be configured as a Transparent Host Adapter card or a Target adapter card. Once installed in any compliant XMC slot, the PXH822 can connect to another PXH822, MXH832, MXH833 or PXH832 configured for Transparent Target operation or any target device compliant to the PCI Express External Cabling Specification 3.0.

The PXH822 supports PCIe Gen1, Gen2 and Gen3 speeds and x1, x2, x4, x8 and x16 link-widths both at the XMC connector side and cable link side. The card will operate at the highest common speed shared between the XMC Carrier card and the PXH822 (up to Gen3) and the widest common link-width (up to x16 using both P15 and P16 XMC connectors).

## Specifications

- ANSI/VITA 42.3-2006 (R2014) Single Width Mezzanine Card
- ANSI/VITA 42.0-2016
- PCI Express Base Specification, Rev. 3.0.
- PCI Express CEM Specification, Rev. 3.0.
- PCI Express External Cabling specification 3.0 (Work in progress, rev 0.9)
- PCI Express Gen3 8.0 GT/s per lane signaling – 128 GT/s total signaling.
- XMC 1.0 Connectors
  - XMC P15 PCI Express Gen3 x8, x4, x2 or x1 host connection.
  - XMC P16 PCI Express Gen3 x8, support x16 Host merged with P15. Can be configured for REAR-IO.
- Compliant with PCI Express Gen1 through Gen3 computers and IO systems, auto detection.
- The PXH822 supports transparent connections to IO systems (Host and Target operation).
- Quad SFF-8644 cable connector
  - Durability max total 250 mating cycles
- Cable port configurations, up to
  - One x16
  - Two x8
  - Four x4
- Broadcom / Avago / PLX PEX8733 PCI Express Gen3 chipset.
- 132 nanosecond cut-through latency port to port.
- Support for MiniSAS-HD copper cables up to 9 meters (between PXH822 cards, room temperature).
- Support for PCI Express 3.0 copper cables with CMI.
- Support for PCIe Gen3 active optical fibers up to 100 meters.
- Host clock isolation. Automatic support for host running CFC or SSC mode.
- VAUX powered board management controllers for flexible configuration and cable management.
- EEPROM recovery option.
- No PCI Express power domain isolation.
- Supports both 5- and 12-Volt XMC VPWR power supply.
- Power consumption:
  - 12- or 5-Volt supply: Max 14 Watt, typical 10 Watts without AOC attached.
  - +3.3 Volt AUX: Max 1 Watt
- Port power supply (per cable port): 3.3 Volt +/- 5%, 0.6 A
- Operating Temperature: 0°C - 55°C (32°F - 131°F), Air Flow: 150 LFM
- Operating Temperature with AOC: 0°C - 45°C (32°F - 113°F), Air Flow: 150 LFM
- Relative Humidity: 5% - 95% (non- condensing)
- Regulatory
  - CE
  - RoHS
  - FCC Class A.
  - WEEE

## MTBF by Temperature and Environment

The MTBF (in hours) for the PXH822 can be found in the table below. The numbers are calculated using the Telcordia SR-332 issue 2 (2006) standard.

Environment		
Ground fixed, controlled	Ground fixed, uncontrolled	Ground mobile
5.465.317	2.732.659	910.886
4.618.340	2.309.170	769.723
3.862.585	1.931.292	643.764
3.200.338	1.600.169	533.390
2.629.773	1.314.886	438.295
2.145.688	1.072.844	357.615
1.740.477	870.239	290.080
1.405.179	702.590	234.197
1.130.380	565.190	188.397
906.914	453.457	151.152
726.316	363.158	121.053
581.055	290.527	96.842

**Table 1: MTBF vs. Temperature and Environment**

## Packaging

The PXH822 includes the following components.

- PXH822 Adapter Board.
- Face plate for quad SFF-8644 connectors.
- 6 screws for fixing the XMC board and face plate.
- Anti-static bag.

## Pre-Installation Questions

Certain steps should be taken prior to installing the PXH822. You should determine the following configuration requirements.

- Which XMC slot and system will the card be installed in?
- What is the speed and link width of the XMC carrier that the card will be installed in?
- Will the card be used as Transparent host or Transparent target operation?
- What is the operating environment for the Host computer?
- What type and length of cables will be used?
- How to ensure proper operational conditions, temperature and airflow.

## PCIe Slot Determination

The PXH822 supports PCIe Gen1, Gen2 and Gen3 speeds and x1, x2, x4, x8 using XMC connector P15 and x16 link-widths using XMC connector P15+P16. The slot width and speed will affect the performance of the card. The card will auto configure to the slot speed and width.

## PXH822 Host / Target Configuration

The PXH822 can act as either a host adapter or target adapter. The PXH822 has a DIP switch bank to control these functions. The DIP switch labeled SW1 can be found close to the upper edge of the board. The main configuration options are host or target operations. The default DIP switch setting is transparent host x16 operations. Additional settings are target operations, two x8 links, four x4 links or tuning for long copper cables.

## Operating Environment

To maximize lifetime for the product and maintain the warranty, please honor the specified operating temperature and make sure the specified air flow is present:

Operating Temperature: 0°C - 55°C (32°F - 131°F), Air Flow: 150 LFM

Operating Temperature with AOC: 0°C - 45°C (32°F - 113°F), Air Flow: 150 LFM

## Cable Ports and Connections

The PXH822 is designed to support both long and short copper cables and comes with two types of PCIe link tuning parameters. The default configuration supports copper cables between 0.5 and 3 meters or PCIe Gen3 fiber cables (AOC). To use copper cables longer than 3 meters, please use DIP-Switch DIP4 to enable the long cable tuning. If you are connecting the PXH822 to a compliant target device not designed by Dolphin, other settings or limitations may apply.

The PXH822 cable connector is compliant to the SFF-8644 industry specification and supports standard x4/x8 Mini-SAS HD copper cables or x4/x8 PCI Express 3.0 cables compliant to the PCIe External Cabling Specification 3.0. Four x4 or two x8 cables are needed for full PCIe x16 connectivity.

### Cable ports

The PXH822 has a quad SFF-8644 connector. Each port implements 4 PCIe lanes. The ports are numbered as shown in Figure 1 Front panel below. The black thick line indicates the position of the PCB.

### PCI Express 3.0 cables

When used with cables compliant to the new PCIe External Cable standard 3.0, the PXH822 card will transmit a CMI Reset message downstream. The card can be connected to a PXH822 in Target mode or any PCIe device compliant to the new cable standard.

### MiniSAS-HD cables

When used with standard MiniSAS-HD cables that does not support the new CMI functionality, the onboard CPU will synthesize a PCIe #CPERST and forward it to the downstream PXH822 card. CWAKE and CPOWERON is not supported using standard MiniSAS-HD cables.

### Active Optical Cables (AOC)

The PXH822 card is compliant with active fiber optic cables available from Dolphin (Part no: MSFCxxx). No special configuration is required. Up to 100-meter fiber cable is supported. CWAKE and CPOWERON is not supported using standard AOC cables.

## CMI Functionality

The 8.10 firmware release supports the following CMI operations:

- Publishes card and CMI status information in readable memory map
- Supports sending CMI reset and power status messages
- Supports receiving CMI reset and status messages
- Supports receiving indicators (LED/messages).

### REAR-IO

The PXH822 card is designed to support REAR-IO. Please contact Dolphin for more information.

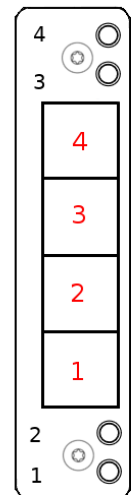

Figure 1 Front panel face plate



# Installation

## Step 1 - Unpack board

The PXH822 card is shipped in an anti-static bag to prevent static electricity damage. The card should only be removed from the bag after ensuring that anti-static precautions are taken. Static electricity from your clothes or work environment can damage your PCI Express adapter card or your PC. Always wear a grounded anti-static wrist strap while opening the PC and when the PXH822 is removed from the anti-static bag. Unpack the PXH822 from the anti-static bag using proper anti-static procedures.



## Step 2 - Configure the Board for Proper Operation

The PXH822 has one bank of 8 DIP switches. The default factory setting for the PXH822 is Transparent mode, short cable, single (up to x16) link connection. The PXH822 has DIP switches for setting special modes or operations. Please carefully read the documentation before modifying any DIP switch settings. Please pay close attention to ON and OFF positions written on the DIP switch.

### DIP Switch Bank – Configuration

Figure 2: DIP Switch shows the DIP switch for the PXH822. It is used to configure the adapter card. Please leave all undocumented DIP switches in the default position. Table 2: DIP Switch settings shows all the various DIP switch settings for the PXH822. The table below lists all options and DIP switch settings for the card

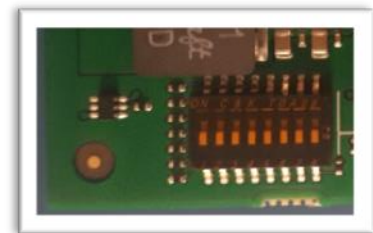

Figure 2: DIP Switch









DIP no.	Description	ON	OFF	Default
1	Configuration selector, details next page Step 2 - Configure the Board for Proper Operation			ON
2	Enable Target or Host operation.	Adapter is configured for transparent Target operations	Adapter is configured for transparent Host operations	OFF
3	Configuration selector, details next page			OFF
4	Enable long copper cable configuration. Please use same setting on both Host and Target	Support copper cables of 4m and longer	Supports copper cables of 0.4-3m length and fiber optic cables	OFF
5	For future use			OFF
6	CMI Disable	Will DISABLE CMI	CMI is supported if a PCIe 3.0 cable is installed	OFF
7	Holds the management processors in reset	Board management is held in reset	Normal operation	OFF
8	Enables the card to boot if the EEPROM has been corrupted	Safe EEPROM	Normal operation	OFF

Table 2: DIP Switch settings

Note: Some DIP switch configuration options may be changed in the future versions. Please always consult the latest user guide for details. This document covers firmware version 8.10.

### DIP-Switch settings for Host operation

The following DIP-Switch settings should be considered when configuring the PXH822 for Transparent Host operation

Configuration PXH822 Host	DIP ON	DIP switch view
Transparent Host One x16 port (Transp set /Shipping Default)	DIP1	
Transparent Host One x16 port Long copper cable tuning	DIP1 DIP4	
Transparent Host Two x8 ports	DIP1 DIP3	
Transparent Host Two x8 ports Long copper cable tuning	DIP1 DIP3 DIP4	
Transparent Host Four x4 ports		
Transparent Host Four x4 ports Long copper cable tuning	DIP4	
Transparent Host One x16 port DMA	DIP3	
Transparent Host One x16 port DMA + Long copper cable tuning	DIP3 DIP4	

**Table 3: PXH822 SW1 Host configuration settings**

The transparent PXH822 DMA configuration setting will enable the onboard DMA engine. A special DMA driver is required to utilize this DMA function.

### DIP-Switch settings for Target operation

The following DIP-Switch settings should be considered when configuring the PXH822 for Transparent Target operation:

Configuration PXH822 Target	DIP ON	DIP switch view
Transparent Target x16 port (port 1+2+3+4) x8 port (port 1+2) x4 port (port 1)	DIP1 DIP2	
Transparent Target Long copper cable tuning x16 port (port 1+2+3+4) x8 port (port 1+2) x4 port (port 1 or 4)	DIP1 DIP2 DIP4	

Table 4: PXH822 SW1 Target configuration settings

### Step 3 - Install the Adapter Card

Before installing the adapter card, make sure you are properly grounded to avoid static discharges that may destroy your computer or the adapter card. Ensure you are properly grounded before opening your computer or the anti-static bag containing the PXH822. Please follow your computer's or expansion chassis manual on how to install a PCI Express card.



The PXH822 Adapter card can be installed into any XMC 1.0 compliant carrier card. The PXH822 supports PCI Express Gen1, Gen2 and Gen3 signaling. NOTE: A Gen3 slot is recommended as it typically doubles the performance compared to a Gen2 slot. Using the XMC P15 connector, the host link will be up to x8. The PXH822 card supports x16 host connections using both P15 and P16.

The PXH822 supports hosts using either spread spectrum or constant frequency clocking. The card implements clock isolation.

To install the card:

1. Ensure the PXH822 face plate is removed from the SFF8644 connector block.
2. Carefully slide the connector side of the PXH822 card through the carrier card front panel cut out.
3. Carefully align the XMC connectors to the connectors on the carrier card and push the PXH822 and the carrier card together.
4. Mount the 4 screws to fix the PXH822 card to the carrier card.
5. Mount the PXH822 front panel face plate around the SFF-8644 connector block – align the LEDs and the holes in the face plate. Fix the two screws.

### Step 4 - Installing and Removing the Cable

Installing and removing cables should be done with both host and expansion system powered off. Please contact your Dolphin representative if you intend to continuously connect and disconnect the PCI Express cables.

#### Connecting the Cable

Please carefully install the cable connector into the connector housing on the PXH822 adapter card. To install the cable, match the cable house with the connector on the PXH822 adapter card. Use even pressure to insert the connector until it is secure. Adhere to ESD guidelines when installing the cables to ensure you don't damage the board. Computer cables should always use strain relief to protect the connected equipment from excessive force on the cable. This is especially important for cables between racks. Note that for wider than x4 connections, the same cable-ports (i.e. port 1 through 4) should be used on both host and target for each individual cable, to ensure that the cards properly link up as x8 or x16.

The PXH822 supports both copper and active optical cables (AOC). Specifications can be found in Table 5. The max distance may change when connecting to other PCIe products.

Cable	Speed	Distance
Copper MiniSAS-HD	Gen3	9 meter
Copper PCIe 3.0 cable	Gen3	TBD
Dolphin MSFC Fiber optic cable (AOC)	Gen3	100 meter

Table 5: Cable Specifications

### Disconnecting the Cable

Please carefully pull the release tab to release the cable from the locking latches and gently pull the cable out of the connector guides.

### Step 6 - Verify Installation & LEDs

The PXH822 comes with 4 bi-color LEDs which show the corresponding cable port status according to Table 6: LED below.

The LEDs are visible through cut-outs in the PCIe bracket on each side of the cable connector block.

LED color	Function
Off	No cable installed
Yellow	Cable installed, no link
Green	Cable installed, link gen 3
Green blinking	Cable installed, link gen 1/2

**Table 6: LED behavior**

## Use Cases Summary and Settings

Table 7: Use Case DIP switch settings below gives an overview of the various use cases, settings and limitations.

Use case	Description	Host DIP switch setting	Target DIP switch setting
A	One Host system having a PXH822 in Host mode connecting to one PXH822 in Target mode or a 3rd party expansion system.	DIP1 ON DIP4 on if long copper cables are used	Single setting for all Target configurations except for long / short copper cable
B	One Host system having a PXH822 in Host mode connecting to two PXH822s in Target mode or two 3rd party expansion systems.	DIP1 ON DIP3 on to enable two x8 links DIP4 on if long copper cables are used	DIP1 ON DIP2 ON  DIP4 on if long copper cables
C	One Host system having a PXH822 in Host mode connecting to four PXH822s in Target mode or four 3rd party expansion systems.	All DIPs off.  DIP4 on if long copper cables are used	All other off

Table 7: Use Case DIP switch settings

## Use Cases

The PXH822 card may be used as both a Host card and a Target card. A Host and Target card can be used as a pair or the Host card can be used with a compliant Target device. The supported use cases and the DIP switch settings are summarized in Table 7: Use Case DIP switch settings. Please use the table to identify the correct DIP switch settings.

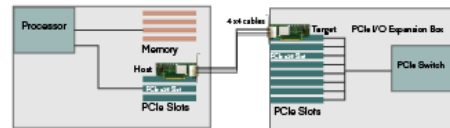

### Use Case A - 1 Host – Single Expansion Configuration

The Host system has a PXH822 adapter configured for Host operation and a direct x4, x8 or x16 link to a PXH822 configured for Target operation.

Figure 3: Use Case A

#### Connecting the cables for single expansion, x16 link

To establish an x16 link, a given port number should be connected to the same port number on the other card.

Always connect a cable from Port #x to Port #x

Host Card Port	Target Card Port
P1	P1
P2	P2
P3	P3
P4	P4

Table 8: Required x16 cabling

A failure connecting any of the cables will cause the link to re-train to x8 or x4.

**Connecting the cables for single expansion, x8 link**

To establish an x8 link, please select one of the alternatives below. Select alternative 1 or 2. To establish proper fail over, please ensure the target x8 configuration is selected (Target card DIP switch).

Alternatives	Host Card Port	Target Card Port
1	P1	P1
	P2	P2
2	P3	P1
	P4	P2

**Table 9: Alternative x8 cabling**

**Connecting the cables for 2 Node Configurations, x4 link**

To establish an x4 link when in dual port mode, please connect any port on the Host card to Port P1 or P4 on the Target card.

**Use Case B – 1 Host - Dual Expansion Configuration**

The host has a PXH822 adapter configured for Host operation and a direct x4 or x8 cable connection is used to connect two independent downstream target systems.

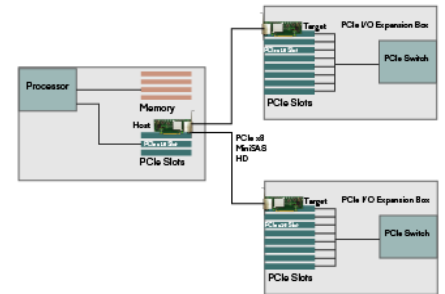

**Figure 4: Use Case B**

**Connecting the cables for Single Node Dual expansion, x8 link**

Connect the cables between the host and target card as described above for x8 connectivity. Connect the second expansion to the free ports. Always connect to port P1 and P2 on the target card.

**Use Case C – 1 Host - Quad Expansion Configuration**

The host has a PXH822 adapter configured for Host mode and a direct x4 cable connection is used between the Host card and each target card. The PXH822 in the Expansion Chassis is configured for Target mode.

**Connecting the cables for Single Node Four expansion, x4 link**

Connect any port on the Host card to port P1 on the Target card.

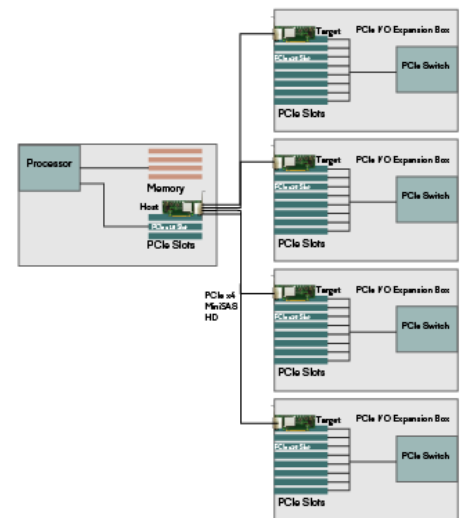

**Figure 5: Use Case C**

## EEPROM and Firmware Upgrade

The PXH822 design uses a microcontroller to implement the PCIe CMI protocol and other maintenance functions. Dolphin may from time to time publish updated firmware for the microcontroller or EEPROM data for the card. Please contact Dolphin for instructions on how to upgrade the PXH822. Please note that standard PLX firmware tools cannot be used to upgrade the firmware.

## Identifying the Card

The card has a label-sticker with the serial number in the format 'PXH822-YY-ZZZZZZ', where YY denotes the card revision (e.g. BB) and ZZZZZZ denotes the serialized production number (e.g. 012345) – this whole string makes up the serial number of the card (i.e. PXH822-BB-012345).

You can also get this information using `lspci` in Linux:

First, identify the devices for the Dolphin Host card:

```
# lspci | grep "Device 8733"
01:00.0 PCI bridge: PLX Technology, Inc. Device 8733 (rev ca)
02:08.0 PCI bridge: PLX Technology, Inc. Device 8733 (rev ca)
```

Then run `lspci`, and identify the card. It will show up as something like

```
# lspci -s 1:0.0 -v
01:00.0 PCI bridge: PLX Technology, Inc. Device 8733 (rev ca) (prog-if 00 [Normal decode])
Flags: bus master, fast devsel, latency 0, IRQ 25
Memory at f7d00000 (32-bit, non-prefetchable) [size=256K]
Bus: primary=01, secondary=02, subordinate=03, sec-latency=0
Capabilities: [40] Power Management version 3
Capabilities: [48] MSI: Enable+ Count=1/8 Maskable+ 64bit+
Capabilities: [68] Express Upstream Port, MSI 00
Capabilities: [a4] Subsystem: Dolphin Interconnect Solutions AS Device 0822
Capabilities: [100] Device Serial Number 00-00-42-42-00-00-00-0a
Capabilities: [fb4] Advanced Error Reporting
Capabilities: [138] Power Budgeting <?>
Capabilities: [10c] #19
Capabilities: [148] Virtual Channel
Capabilities: [e00] #12
Capabilities: [b00] Latency Tolerance Reporting
Capabilities: [b70] Vendor Specific Information: ID=0001 Rev=0 Len=010
Kernel driver in use: pcieport
Kernel modules: shpchp
```

Second,  
do

```
# lspci -s 1:0.0 -v | grep -E "Subsystem|Serial"
Capabilities: [a4] Subsystem: Dolphin Interconnect Solutions AS Device 0822
Capabilities: [100] Device Serial Number 00-00-42-42-00-00-00-0a
```

This shows the card as revision 0x4242 (hexadecimal values of the 'BB' letters in the ASCII table), with the production number 0x0000000A (0000010 in decimal).

## Technical Information

### PCIe Cable Port Signals

The external PCI Express SFF-8644 cable connector supports the following signals:

- PETpN/PETnN: PCI Express Transmitter pairs, labeled where N is the Lane number (starting with 0); “p” is the true signal while “n” is the complement signal.
- PERpN/PERnN: PCI Express Receiver pairs, labeled where N is the Lane number (starting with 0); “p” is the true signal while “n” is the complement signal.
- PWR: Power to support AOC and signal conditioning components within the cable assembly.
- MGTPWR: Power supplied to the connector for cable management components that are needed while the link is not active. This needs to be active if the subsystem has power.
- CBLPRSNT#: Cable present detect, an active-low signal pulled-down by the cable when it is inserted into the PXH822 connector.
- CADDR: Signal used to configure the upstream cable management device address.
- CINT#: Signal asserted by the cable assembly to indicate a need for service via the CMI controller.
- CMISDA: Management interface data line. Used for both initial link setup and sideband messages when used with CMI compliant cables.
- CMISCL: Management interface clock line. Used for both initial link setup and sideband messages when used with CMI compliant cables.

### External PCIe x4 Cable Connector Pin-Out

	Column								
Row	9	8	7	6	5	4	3	2	1
D	GND	PETn2	PETp2	GND	PETn1	PETp1	GND	MGTPWR	PWR
C	GND	PETn3	PETp3	GND	PETn0	PETp0	GND	CMISDA	CMISCL
B	GND	PERn2	PERp2	GND	PERn1	PERp1	GND	CBLPRSNT#	PWR
A	GND	PERn3	PERp3	GND	PERn0	PERp0	GND	CINT#	CADDR

Table 10; External PCIe x4 cable Pin-Out

### PCIe Cable Port Mapping

The PXH822 card have a quad SFF-8644 connector. The ports are mapped as showed in the table below. The card utilized PCIe lane reversal.

Cable Port	x16	Dual x8	Quad x4	PCIe 3.0 Cable Pin
1	L15	L7	L3	TX0/RX0
	L14	L6	L2	TX1/RX1
	L13	L5	L1	TX2/RX2
	L12	L4	L0	TX3/RX3
2	L11	L3	L3	TX0/RX0
	L10	L2	L2	TX1/RX1
	L9	L1	L1	TX2/RX2
	L8	L0	L0	TX3/RX3
3	L7	L7	L3	TX0/RX0
	L6	L6	L2	TX1/RX1
	L5	L5	L1	TX2/RX2
	L4	L4	L0	TX3/RX3
4	L3	L3	L3	TX0/RX0
	L2	L2	L2	TX1/RX1
	L1	L1	L1	TX2/RX2
	L0	L0	L0	TX3/RX3

Table 11 : PCIe Cable Port Mapping



## Compliance and Regulatory Testing

### EMC Compliance

The Dolphin PCI Express PXH822 adapter has been tested to the following relevant test standards for PCI Express cards, telecommunication and industry equipment installed in a standard PC:

EN 55032:2012,  
EN 55035:2017,  
EN 61000-3-2:2014,  
EN 61000-3-3:2013  
CISPR 32:2012 First Edition  
CISPR 35:2016 Edition 1.0 (CISPR/1/412/CDV)  
47 CFR Part 15, Subpart B (Clause 15.107 and 15.109)



This does not ensure that it will comply with these standards in any random PC. It is the responsibility of the integrator to ensure that their products are compliant with all regulations where their product will be used.

### RoHS Compliance

The Dolphin PXH822 is RoHS compliant. A Compliance certificate issued by the manufacturer is available upon request.



### FCC Class A

This equipment has been tested and found to comply with the limits for a Class A digital device, pursuant to part 15 of the FCC Rules.



## Limited Warranty

Dolphin Interconnect Solutions warrants this product to be free from manufacturing defects under the following terms:

### Warranty Period

The warranty applies for one (1) year from the date of purchase. Extended warranty is available.

### Coverage

To the extent permitted by applicable law, this warranty does not apply to:

- Damage caused by operator error or non-compliance with instructions available for the product.
- Use or attempt to use or program firmware not approved by Dolphin.
- Damage due to accidents, abuse, misuse, improper handling or installation, moisture, corrosive environments, high voltage surges, shipping, or abnormal working conditions.
- Damage caused by acts of nature, e.g. floods, storms, fire, or earthquakes.
- Damage caused by any power source out of range or not provided with the product.
- Normal wear and tear.
- Attempts to repair, modify, open, or upgrade the product by personnel or agents not authorized by Dolphin.
- Products for which the serial number label has been tampered with or removed.
- Damage to the product caused by products not supplied by Dolphin.

### Service Procedure

In the event that the product proves defective during the Warranty Period, you should contact the seller that supplied you with the product, or if you purchased it directly from Dolphin, visit <https://www.dolphinics.com/csp> to obtain a valid RMA number and instructions. Products returned to Dolphin without a proper RMA number will not be serviced under this warranty.

## Product Revision history

The following tables gives a general overview of the hardware and firmware capabilities and changes. Please contact Dolphin if you have any questions.

### Adapter revision

The adapter revision covers the PCB and BOM changes. The revision can be found on the serial number label located on the card.

Adapter revision	Capabilities / Changes
PXH822-AA	<ul style="list-style-type: none"><li>Internal version. Early users should return the card to Dolphin.</li></ul>
PXH822-BB	<ul style="list-style-type: none"><li>Initial production version</li></ul>

## BMC Firmware versions

The BMC Firmware version is covering the BMC firmware changes. The current firmware version can be found by running the dis\_diag utility. The BMC firmware is field upgradeable.

BMC Firmware version	Capabilities / Changes
8.10	<ul style="list-style-type: none"><li>Initial production version</li></ul>

## EEPROM Versions

The EEPROM Versions is covering the PCIe Switch configuration data. The current EEPROM version can be found by running the dis\_diag utility. The EEPROM data is field upgradable.

EEPROM version	Capabilities / Changes
2	<ul style="list-style-type: none"><li>Initial production version</li></ul>

## Support

More information about the product, support and software download can be found at <http://www.dolphinics.com/px>. For general support questions, please contact Dolphin via the Jira Service Management portal: <https://www.dolphinics.com/csp>.